

Crutches



www.rebotec.co.uk

ECO 100 / ECO 120

Crutch

Equipment:

- strong nontwisting forearm cuff
- ergonomic handle
- reflector
- solid ferrule with a high diameter

Eco 100

Standard-Clip

- 10 adjustments in height
- approved up to 100 kg body weight

ref.no. 100.20. ...

Eco 120

Standard-Druck

- 10 adjustments in height
- approved up to 120 kg body weight

ref.no. 100.22. ...

Accessories:

- Handle upholstery „Standard“
ref.no. 160.01.02
- Crutch-Strap
ref.no. 167.00. ...



ref.no. 100.20.10



ref.no. 100.22.50

Colours	Colourcode
grey	00
black	10
blue	50

Type:	Eco 100	Eco 120
height from handle to cuff:	21,5 cm	21,5 cm
height of handle:	73,5 cm - 96 cm	74,5 cm - 97 cm
diameter Ø in mm:	20/16,9	20/19
ref.no.:	100.20. ...	100.22. ...

Überlänge

Crutch "excess length"



ref.no. 104.50



Simply ...



stick together ...



and the crutch stays!

Type:	Überlänge
height from handle to cuff:	24 cm
height of handle:	85 cm - 108 cm
diameter Ø in mm:	22/19
ref.no.:	104. ..

Crutch "excess length" with the new patented locking system

Equipment:

- strong nontwisting forearm cuff
- ergonomic handle
- reflector
- 10 adjustments in height
- compression fitting
- solid ferrule with a high diameter
- approved up to 130 kg body weight

ref.no. 104. ..

Accessories:

- Handle upholstery „Standard“
ref.no. 160.01.02
- Forearm upholstery
ref.no. 160.02.02
- Crutch-Strap
ref.no. 167.00. ..

Colours	Colourcode
grey	00
black	10
yellow	20
fire-red	30
claret	40
blue	50
dark-green	60
turquoise-blue	80
turquoise-green	90

Technical changes and changes in colour reserved.



Magic-Twin

Crutch with patented locking system

Equipment:

- strong nontwisting forearm cuff
- ergonomic handle
- reflector
- solid ferrule with a high diameter
- approved up to 130 kg body weight

Standard-Clip

- 10 adjustments in height
- ref.no. 101. ..**

Quetsch-Druck

- 10 adjustments in height
- compression fitting

ref.no. 102. ..

Quetsch-Clip

- 10 adjustments in height
- compression fitting

ref.no. 103. ..

Accessories:

- Handle upholstery „Standard“
ref.no. 160.01.02
- Forearm upholstery
ref.no. 160.02.02
- Crutch-Strap
ref.no. 167.00. ..
- TriPod (for 102/103)
ref.no. 169.10



Type:	Standard-Clip	Quetsch-Druck	Quetsch-Clip
height from handle to cuff:	24 cm	24 cm	24 cm
height of handle:	75 cm - 98 cm	75 cm - 98 cm	75 cm - 98 cm
diameter Ø in mm:	22/19	22/19	22/19
ref.no.:	101. ..	102. ..	103. ..

Colours	Colourcode
grey	00
black	10
yellow	20
fire-red	30
claret	40
blue	50
dark-green	60
turquoise-blue	80
turquoise-green	90

Magic-Soft Magic-Soft-Anatom

Crutch with patented locking system



Simply ...



stick together ...



and the crutch stays!



ref.no. 105.30

Equipment:

- strong nontwisting forearm cuff
- soft handle
- reflector
- 10 adjustments in height
- compression fitting
- solid ferrule with a high diameter
- approved up to 130 kg body weight

Magic-Soft

- ergonomic shaped soft handle
- ref.no. 105. ...**

Magic-Soft-Anatom

- anatomic shaped soft handle
- ref.no. 107. ...**

Accessories:

- Forearm upholstery
ref.no. 160.02.02
- Crutch-Strap
ref.no. 167.00. ...
- TriPod
ref.no. 169.10

Soft handle

Colours	Colourcode
grey	00
black	10
fire-red	30
claret	40
black/cork	48
blue	50
turquoise-blue	80

Type:	Magic-Soft	Magic-Soft-Anatom
height from handle to cuff:	24 cm	24 cm
height of handle:	75 cm - 98 cm	75 cm - 98 cm
diameter Ø in mm:	22/19	22/19
ref.no.:	105. ...	107. ...

Technical changes and changes in colour reserved.



Fun-Kids

Crutch for children

Equipment:

- colourful, suitable for children
- 3 adjustments in height from handle to cuff
- ergonomic handle
- reflector
- 10 adjustments in height
- compression fitting
- approved up to 100 kg body weight

ref.no. 122. ..

Accessories:

- Handle upholstery „Mini“
ref.no. 160.01.01

*Adjustable
forearm cuff!*



ref.no. 122.95



ref.no. 122.96



Type:	Fun-Kids
height from handle to cuff:	16 cm - 21 cm
height of handle:	50 cm - 78 cm
diameter Ø in mm:	20/16,9
ref.no.:	122. ..

Colours	Colourcode
blue-colourful	95
yellow-colourful	96
blue	50

Light-Line

Crutch for youth and ladies



ref.no. 120.00



ref.no. 120.10



ref.no. 120.50

Equipment:

- small shaped forearm cuff and handle
- 3 adjustments in height from handle to cuff
- ergonomic handle
- reflector
- 10 adjustments in height
- compression fitting
- approved up to 100 kg body weight

ref.no. 120. ...

Accessories:

- Handle upholstery „Mini“
ref.no. 160.01.01

Adjustable forearm cuff!



Colours	Colourcode
grey	00
black	10
blue	50

Type:	Light-Line
height from handle to cuff:	16 cm - 21 cm
height of handle:	75 cm - 97 cm
diameter Ø in mm:	20/16,9
ref.no.:	120. ...



Combi / Combi Soft

Double adjustable crutch

Equipment:

- 3 adjustments in height from handle to cuff
- compression fitting
- approved up to 130 kg body weight

Combi

- ergonomic handle
- reflector front/backwards
- 10 adjustments in height

ref.no. 115. ..

Combi-Soft

- ergonomic shaped soft handle
- reflector backwards
- 10 adjustments in height

ref.no. 109. ..

Accessories:

- Handle upholstery „Standard“
ref.no. 160.01.02
- Forearm upholstery
ref.no. 160.02.02
- Crutch-Strap
ref.no. 167.00. ..



ref.no. 115.00



ref.no. 109.50



Adjustable forearm cuff!

Colours	Colourcode
grey	00
black	10
fire-red	30
blue	50
turquoise-blue	80

Type:	Combi	Combi-Soft
height from handle to cuff:	22 cm - 25 cm	22 cm - 25 cm
height of handle:	75 cm - 97 cm	75 cm - 97 cm
diameter Ø in mm:	22/19	22/19
ref.no.:	115. ..	109. ..

Comfort / Comfort-Soft

Double adjustable anatomic crutch



ref.no. 112.00



ref.no. 110.80

Adjustable forearm cuff!

Equipment:

- 3 adjustments in height from handle to cuff
- reflector backwards
- 10 adjustments in height
- compression fitting
- approved up to 130 kg body weight

Comfort

- rotatable handle

ref.no. 112. ...

Colour	Colourcode
grey	00
blue	50

Comfort-Soft

- soft handle

ref.no. 110. ...

Colour	Colourcode
grey	00
black	10
fire-red	30
black/cork	48
blue	50
turquoise-blue	80

Accessories:

- Handle upholstery „Anatom“ ref.no. 160.01.04
- Forearm upholstery ref.no. 160.02.02
- Crutch-Strap ref.no. 167.00. ...

Type:	Comfort	Comfort-Soft
height from handle to cuff:	22 cm - 25 cm	22 cm - 25 cm
height of handle:	75 cm - 97 cm	75 cm - 97 cm
diameter Ø in mm:	22/19	22/19
ref.no.:	112. ...	110. ...

Safe-In-Kids / Safe-In-Light

Crutch with nearly closed forearm cuff



Equipment:

- forearm cuff with hinge to increase the mobility
- 3 adjustments in height from handle to cuff
- ergonomic handle
- reflector
- 10 adjustments in height
- compression fitting
- solid ferrule with a high diameter
- approved up to 100 kg body weight

Safe-In-Kids

crutch for children

ref. no. 122. ... 10

Colour "Kids"	Colourcode
blue-colourful	 95
yellow-colourful	 96
blue	 50

Safe-In-Light

crutch for youth and ladies

ref. no. 120. ... 10

Colour "Light"	Colourcode
blue	 50

Accessories:

- Handle upholstery "Mini"
ref.no. 160.01.01
- Nonsliding rubber "Big-Foot"
ref. no. 168.10.16

Type:	Safe-In-Kids	Safe-In-Light
height from handle to cuff:	16 cm - 21 cm	16 cm - 21 cm
height of handle:	50 cm - 78 cm	75 cm - 97 cm
diameter Ø in mm:	20/16,9	20/16,9
ref. no.:	122. ... 10	120. ... 10

ref. no. 122.96.10



ref. no. 122.95.10

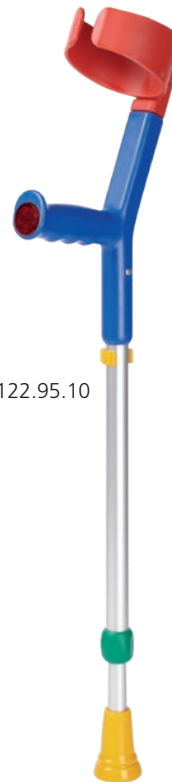

ref. no. 120.50.10



Safe-In

Crutch with nearly closed forearm cuff



ref. no. 116.50

*Adjustable to-
rear arm cuff*

Equipment:

- forearm cuff with hinge to increase the mobility
- 3 adjustments in height from handle to cuff
- ergonomic handle
- reflector front/backwards
- 10 adjustments in height
- compression fitting
- solid ferrule with a high diameter
- approved up to 130 kg body weight

ref. no. 116. ..

Accessories::

- Handle upholstery „Standard“
ref.no. 160.01.02
- Nonsliding rubber “Big-Foot”
ref. no. 168.10.17



Type:	Safe-In
height from handle to cuff:	22 cm - 25 cm
height of handle:	75 cm - 97 cm
diameter Ø in mm:	22/19
ref. no.:	116. ..

Colour	Colourcode
grey	00
black	10
fire-red	30
blue	50
turquoise-blue	80

Safe-In-Excess length

Crutch with nearly closed forearm cuff

Equipment:

- forearm cuff with hinge to increase the mobility
- 3 adjustments in height from handle to cuff
- ergonomic handle
- reflector front/backwards
- 10 adjustments in height
- compression fitting
- solid ferrule with a high diameter
- approved up to 130 kg body weight

ref. no. 116...20

Accessories:

- Handle upholstery „Standard“
ref.no. 160.01.02
- Nonsliding rubber “Big-Foot”
ref. no. 168.10.17



ref. no. 116.50.20

Nearly closed forearm cuff!



Colour	Colourcode
grey	00
black	10
fire-red	30
blue	50
turquoise-blue	80

Type:	Safe-In-Overlength
height from handle to cuff:	22 cm - 25 cm
height of handle:	85 cm - 107 cm
diameter Ø in mm:	22/19
ref. no.:	116...20

Safe-In-Soft

Safe-In-Anatom-Soft

Crutch with nearly closed forearm cuff



ref. no. 118.80



ref. no. 117.10

*Soft
handle!*

Equipment:

- forearm cuff with hinge to increase the mobility
- 3 adjustments in height from handle to cuff
- reflector backwards
- 10 adjustments in height
- compression fitting
- solid ferrule with a high diameter
- approved up to 130 kg body weight

Safe-In-Soft

- ergonomic soft handle

ref. no. 117. ..

Safe-In-Anatom-Soft

- anatomic soft handle

ref. no. 118. ..

Accessories:

- Handle upholstery "Standard" ref. no. 160.01.02
- Handle upholstery "Anatom" ref. no. 160.01.04
- Nonsliding rubber "Big-Foot" ref.no. 168.10.17



Type:	Safe-In-Soft	Safe-In-Anatom-Soft
height from handle to cuff:	22 cm - 25 cm	22 cm - 25 cm
height of handle:	75 cm - 97 cm	75 cm - 97 cm
diameter Ø in mm:	22/19	22/19
ref. no.:	117. ..	118. ..

Colour	Colourcode
grey	00
black	10
fire-red	30
blue	50
turquoise-blue	80

BIG 150 / BIG 250

Crutch with patented locking system

Equipment:

- wide cuff
- 3 adjustments in height from handle to cuff
- ergonomic handle
- reflector

BIG 150

- very light aluminium tube
- approved up to 150 kg body weight

ref.no. 106.10

BIG 250

- 10 adjustments in height
- incl. nonsliding rubber "Big-Foot"
- approved up to 250 kg body weight

ref.no. 106.00. ...

BIG 250 „excess length“

- 10 adjustments in height
- + 10 cm length
- incl. nonsliding rubber "Big-Foot"
- approved up to 250 kg body weight

ref.no. 106.04. ...

Accessories:

- Handle upholstery „BIG“
ref.no. 160.01.03
- Forearm upholstery
ref.no. 160.02.03
- Crutch-Strap
ref.no. 167.00. ...

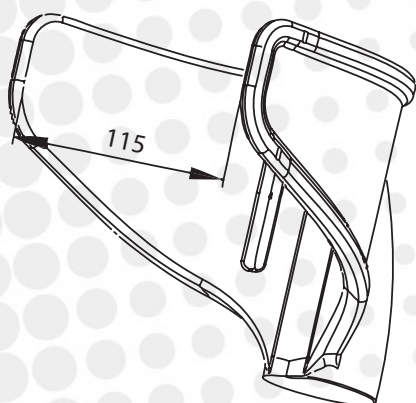

Up to 150 kg!

ref.no. 106.00.10

ref.no. 106.10
Shown with accessory
"BIG Foot"

Up to 250 kg!

Colour	Colourcode
grey	00
black	10

Type:	BIG 150	BIG 250	BIG 250 „ÜL“
height from handle to cuff:	22 cm - 25 cm	22 cm - 25 cm	22 cm - 25 cm
height of handle:	max. 108 cm	74 cm - 97 cm	84 cm - 107 cm
diameter Ø in mm:	22	25/22	25/22
ref.no.:	106.10	106.00. ..	106.04. ..

New Walk

Comfortable soft springing crutch



Comfortable soft springing crutch with soft handle

- walking free of pain thanks to the soft springing of the crutch
- relief to the wrist and muscles

Equipment:

- 3 adjustments in height from handle to cuff
- 7 adjustments in height
- reflector backwards
- absorbing springs inside the tube are protecting against shocks
- 2 damper settings possible – without tools
- solid ferrule with a high diameter
- approved up to 130 kg body weight

New Walk (ergonomic)

- ergonomic soft handle

ref.no. 125.50

New Walk (anatomic)

- anatomic soft handle

ref.no. 124.50

Accessories:

- Handle upholstery „Standard“
ref.no. 160.01.02
- Handle upholstery „Anatom“
ref.no. 160.01.04
- Forearm upholstery
ref.no. 160.02.02
- Crutch-Strap
ref.no. 167.00. ...

Type:	New Walk (ergonomic)	New Walk (anatomic)
height from handle to cuff:	22 cm - 25 cm	22 cm - 25 cm
height of handle:	80 cm - 100 cm	80 cm - 100 cm
diameter Ø in mm:	22/19	22/19
ref.no.:	125.50	124.50

Travel / Big Travel

Crutch for the journey

Travel

Detachable crutch for the journey

Equipment:

- detachable – longest piece: 44 cm
- delivery inclusive bag
- 3 adjustments in height from handle to cuff
- ergonomic handle
- reflector front/backwards
- 8 adjustments in height
- compression fitting
- solid ferrule with a high diameter
- approved up to 130 kg body weight

ref.no. 108.50

BIG Travel

Double telescopable crutch for the journey

Equipment:

- 3 adjustments in height from handle to cuff
- ergonomic handle
- reflector front
- 9 adjustments in height
- double telescopable tube set
- solid ferrule with a high diameter
- approved up to 150 kg body weight

ref.no. 108.00



ref.no. 108.50

ref.no. 108.00

The travel support !

Type:	Travel	BIG Travel
height from handle to cuff:	22 cm - 25 cm	22 cm - 25 cm
height of handle:	81 cm - 95 cm	80 cm - 100 cm
diameter Ø in mm:	22/19/22	25/22/19
ref.no.:	108.50	108.00

Accessories

for crutches



Ice-Pick

- 5 thorns for safe standing
- easy to turn up on normal ground
- easy assembling
- suitable for a tube diameter of 16 mm – 22 mm

ref.no. 166.00.05

ref.no. 166.00.05



Order form see last page

Technical changes and changes in colour reserved.



Accessories

for crutches



Crutch-Strap

Elastic crutch-strap

In everyday life you need to have free hands to manage the simple things. Thus, users of crutches are facing a problem. Easy to install just hang your crutches over your shoulder to get your hands free.

To fit the crutch-strap is adjustable in length.

Colour	Colourcode
anthracite	16
fire-red	30
blue	50

ref.no. 167.00. ..

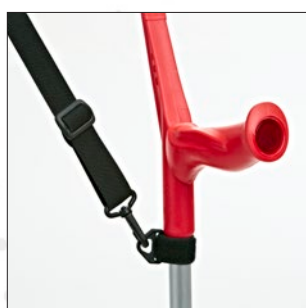
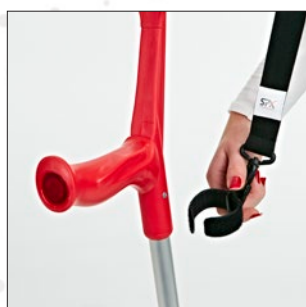

Sapo Flex

Elastic crutch-strap with neck padding

ref.no. 167.00.10



Order form see last page

Technical changes and changes in colour reserved.

protected by patent

CE

Accessories

for crutches



Flip

Holder for walking-sticks

Ideal for all walking-sticks with a tube diameter from 20 mm to 22 mm.

Types:

FLIP for 20 mm tubes

ref.no. 164.20.00

FLIP for 22 mm tubes

ref.no. 164.10.00



50 pieces in a sales display.



Logo

Holder for walking-aids with 22 mm tube diameter

ref.no. 165.10.22



50 pieces in a sales display.
Available with your logo!

Order form see last page

Technical changes and changes in colour reserved.

protected by patent



Accessories

for crutches



Attach TriPod
to the
forearm crutches.



To unfold
push down
the red button ...



... until it clicks into place.



3 steps to stand firm!

TriPod

Forearm Crutches Stand

In everyday life you often need free hands for the simplest things. Therefore, users of forearm crutches having a problem.

- easy to assemble
- fits all models with compression fitting and tube diameter 22mm

ref.no. 169.10

*... simple, practical
and stable!*



Accessories

for crutches



Handle upholstery and forearm upholstery for Crutches

- the material is kind to the skin and reduces the pressure
- nonsliding upholstery through neopren
- pleasant to the skin because of the nylon cover
- simple fastening through velcro
- washable

1. Handle upholstery „Mini“

for „Kids“ and „Light“

ref.no. 160.01.01

2. Handle upholstery „Standard“

for crutches with standard handle

ref.no. 160.01.02

3. Handle upholstery „Anatom“

for crutches with anatomic handle

ref.no. 160.01.04

4. Forearm upholstery

for Magic-Twin, Combi, Comfort

ref.no. 160.02.02

5. Forearm upholstery

for BIG 150 / BIG 250

ref.no. 160.02.03

6. Handle upholstery

for BIG 150 / BIG 250

ref.no. 160.01.03



BIG shown with upholstery

Technical changes and changes in colour reserved.



Accessories

for crutches



BIG-Foot

nonsliding rubber

- large bottom (Ø 5,6 cm)
- very flexible through special shape
- nonslipping, high durable material

BIG-FOOT · 16 mm – 17,5 mm

ref.no. 168.10.16

BIG-FOOT · 18,5 mm – 20,5 mm

ref.no. 168.10.17

BIG-FOOT · 22 mm – 24 mm

ref.no. 168.10.22



Ferrules

Ferrule 17 mm

ref.no. 200.10

Ferrule 19 mm

ref.no. 200.00

Ferrule 22 mm

ref.no. 200.20

Colour	Colourcode
grey	00
black	10
yellow	20
fire-red	30
claret	40
blue	50
dark-green	60
turquoise-blue	80
turquoise-green	90

Order form see last page

Technical changes and changes in colour reserved.



Accessories

for crutches



Walking aids holding devices

SYSTEM **toolflex**®©

1. Toolflex-holder for separate and rail mounting
ref.no. 164.10.30

2. Toolflex-aluminium rail (without holder)

- 20 cm for 2 holders
ref.no. 164.10.40
- 50 cm for 5 holders
ref.no. 164.10.35
- 90 cm for 9 holders
ref.no. 164.10.39

3. Toolflex-holder for mounting on tubes

- incl. 22 mm, 25 mm or 30 mm tubefitting
- 22 mm
ref.no. 164.10.10
 - 25 mm
ref.no. 164.10.15
 - 30 mm
ref.no. 164.10.18

4. Toolflex-support cup

- incl. tubefitting
- support cup with 22 mm tubefitting
ref.no. 164.10.20
 - support cup with 25 mm tubefitting
ref.no. 164.10.25
 - support cup with 30 mm tubefitting
ref.no. 164.10.28

5. Set for REBOTEC-Rollators

- holder with 25 mm tubefitting
- support cup with 30 mm tubefitting (picture 3. + 4.)
ref.no. 164.30.00



Accessories

for crutches



ref.no. 396.00



Duo Support Camp

- practical support system for various applications
- walking-sticks and crutches ready to hand
- reduces the risk of accidents
- flexible and easy to install
- protecting the furniture (without screws)

ref.no. 396.00

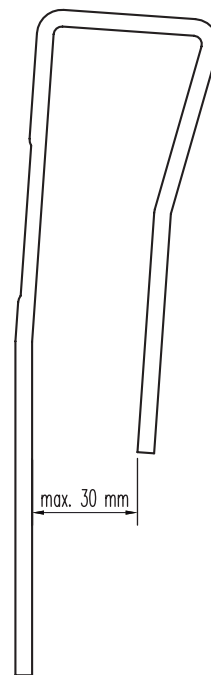

*Versatile
adaptable!*

Type:	Duo Support Camp
width:	150 mm
height:	160 mm
max. rail width:	30 mm
diameter Ø in mm:	20/30
ref.no.:	396.00

Accessory box



Mix-Box (5)



FAX: +49 (0) 5431 9416-66

Date

Customer number

Order number

Name

Place

ref. no.	article	Qty/Box	Colour	Size	Qty
167.00...	Crutch-Strap	5	(16) anthracite		
			(30) fire-red		
			(50) blue		
160.01.02	Handle upholstery	30	(10) black		
165.10.22	Logo	50	(10) black	22 mm	
168.10.16	Big Foot	12	(10) black	16 - 17,5 mm	
168.10.17	Big Foot		(10) black	18,5 - 20,5 mm	
168.10.22	Big Foot		(10) black	22-24 mm	
200....10	Ferrules	24	(00) grey	17 mm	
			(10) black		
			(20) yellow		
			(50) blue		
200....00	Ferrules	24	(00) grey	19 mm	
			(10) black		
			(20) yellow		
			(30) fire-red		
			(40) claret		
			(50) blue		
			(60) green		
166.00	Ice-Pick	14	(80) turquoise-blue		
			(90) turquoise-green		

choice of mix-boxes (please tick)

1)	Big Foot	6		Please use one order form for each box! Please insert above colours and sizes!
	Ferrules	14		
2)	Crutch-Strap	2		
	Handle upholstery	10		
	Holding device	6		
3)	Handle upholstery	16		
	Holding device	10		
	Big Foot	4		
4)	Handle upholstery	16		
	Holding device	10		
	Ferrules	10		
5)	Handle upholstery	16		
	Ferrules	16		

Shipment to

Sign

